

QUOTIENT, THE GAME - THE REDACTED, THE SPOILER FREE MAP!

You start at the end of a lane leading to the Quotient Spy Headquarters. There is no public map of the Quotient farmstead or complex, so you'll need to find your own way around there. From HQ, you can get to some well understood places like Oxford, DC, Cincinnati, Cleveland, and Africa. Oh, and a Spaceport too. These locations are mapped here since they are well known locations.

Good Luck!

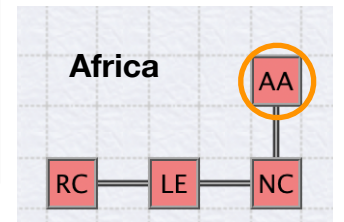
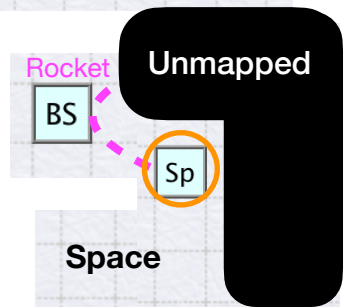
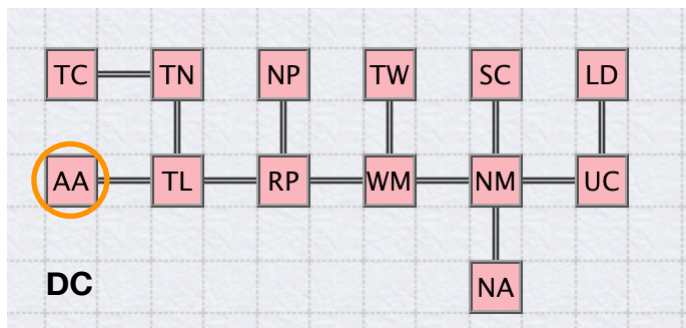
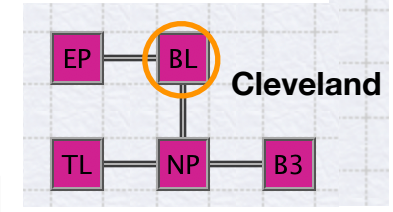
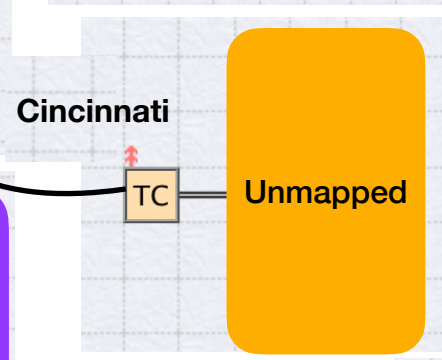
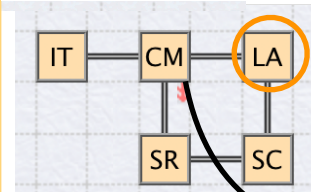
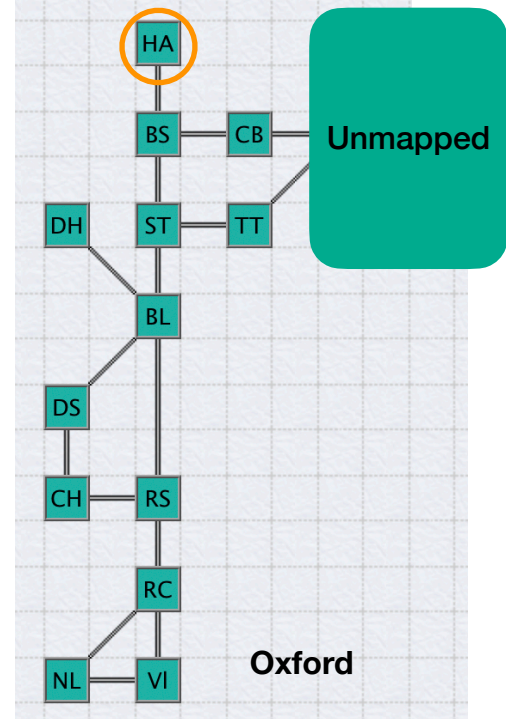

- SC Farmstead Area: Security Checkpoint, [REDACTED]
- SP HQ Area: [REDACTED]
- HA Oxford University: Hidden Airbase, Broad Street, Sheldonian Theatre, Clarendon Building, Bodleian Library, Radcliffe Square, Radcliffe Camera, Duke Humfreys Library, Divinity School, Convocation House, [REDACTED] The Turf Tavern, Vaults_Garden, Narnia Lamp, [REDACTED]
- LA Cincinnati Area: Lunken Airport, Cincinnati Museum Center, The Cavern, IMAX Theater, Skyline Chili, [REDACTED]
- BL Cleveland Area: Burke Lakefront, Nela Park, Building 336, The Lighting Institute, Edgewater Park
- Sp Outerspace Area: Spaceport, [REDACTED] Blackness of Space
- AA Africa Area: Arusha Airport, Ngorogoro Crater, Lalibela Ethiopia, Rock Church St George
- AA DC Area: Andrews Air Force Base, National Mall, Washington Monument, The White House, The Lincoln Memorial, The National Cathedral, The Chapel, US Capitol, Smithsonian Castle, National Portrait Gallery, Lawsons Deli, Reflecting Pool, National Air Space Museum

FUN ASIDES

- EXAMINE [OBJECTS] and *scenery* (Scenery is in Italic print in descriptions)
- EXAMINE the TARDIS COMMUNICATOR many times (you can get different responses in different locations)
- EXAMINE [PEOPLE]
- EXAMINE JACK (multiple times)
- Find the Cave Map
- ASK [PEOPLE] About [PEOPLE]
- ASK ROBOT ABOUT POD BAY DOORS
- Build a bonfire with Desmond
- READ THINGS... eg: Books, Mountain Dew and more.
- Smell things, listen to things, eat a 3-way!
- Watch TV, you can tune into at least 5 channels
- Consult intel on Tardis/Martin etc
- There are at least 9 viewable photos in the game.
- Every treasure (except most food) has a clue within it to help you.

SCORING

- There are 20 treasures worth 2 points each. (2 specific treasures are required to win.)
- There are two 2 point activities not required to win the game.
- There is one 3 point activity that is helpful in solving the game.
- There four 5 point items required to win the game.
- There are four 10 point actions required to solve the game
- The above actions total to 107 points.
- Another 107 points is awarded when you do the final winning move for a total of 214 points.

There are 2 mazes in honor of the original Adventure Game and Zork. A corn maze and cave maze.